

FIXE

0082 $7 \leq \varnothing \leq 13 \text{ mm}$ individually tested
 EN 12278: 2007

Pulley
Poulie

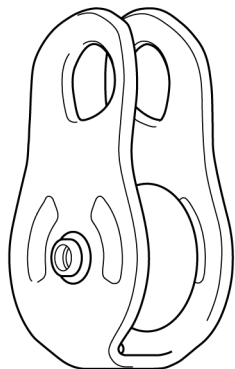

Traceability and markings

Traçabilité et marquage

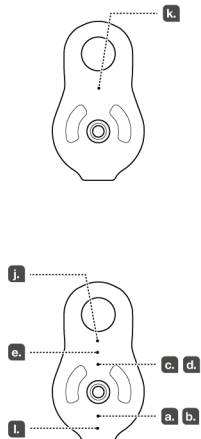

CE 0082	
a.	Body controlling the manufacture of this PPE
b.	Notified body that carried out the EU type inspection
APAVE SUDEUROPE SAS 8 rue Jean-Jacques Vermezza Z.A.C. Saumaty-Séon - CS 60193 13322 Marseille CEDEX 16 N°0082	
c.	Traceability: datamatrix
d.	Diameter
e. Serial number YY M 0000000 000	
f.	Year of manufacture
g.	Month of manufacture
h.	Batch number
i.	Individual identifier
f. Standards	
k. Carefully read the instructions for use	
l. Manufacturer address	

1. Field of application (text part)

Champ d'application (partie texte)

2. Nomenclature

Nomenclature

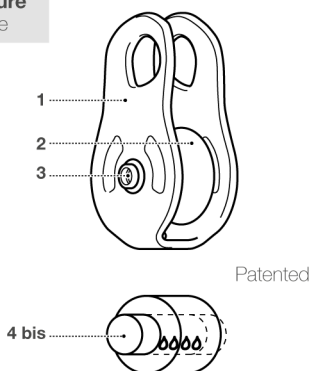

3. Inspection, points to verify

Contrôle, points à vérifier

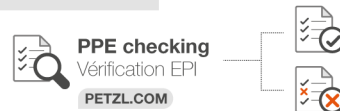

4. Compatibility

Compatibilité

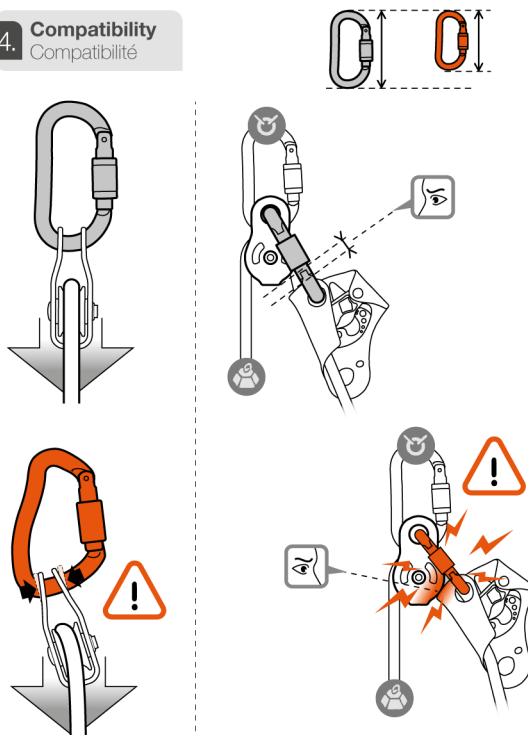

5. Strength

Résistance

5A. Working load limit

Valeur d'utilisation maxi

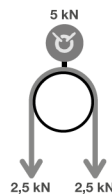

5B. Breaking load

Charge de rupture

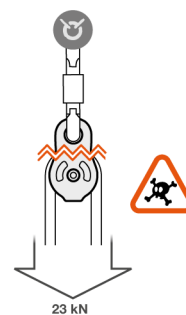

6A. Simple pulley system

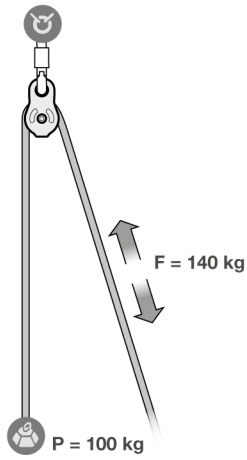

with progress capture

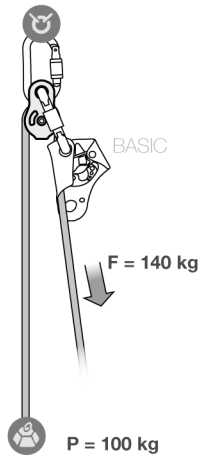

6B. 2:1 hauling system

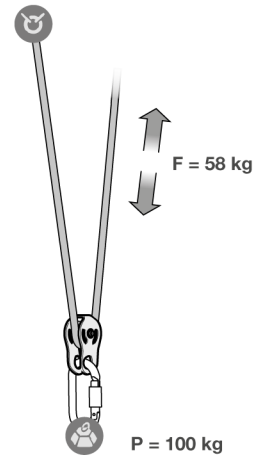

Theoretical force



	$F = P$
	$F = 1,4 P$
	$F = 2 P$

	$F = 0,5 P$
	$F = 0,58 P$
	$F = 0,66 P$

6C. 3:1 hauling system with progress capture

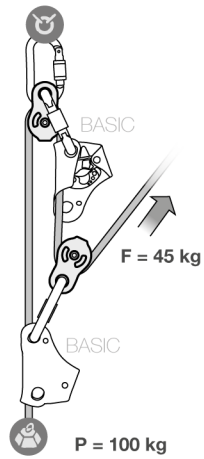

Theoretical force



	$F = 0,33 P$
	$F = 0,45 P$
	$F = 0,57 P$

7. Progress capture systems
Systèmes anti-retour

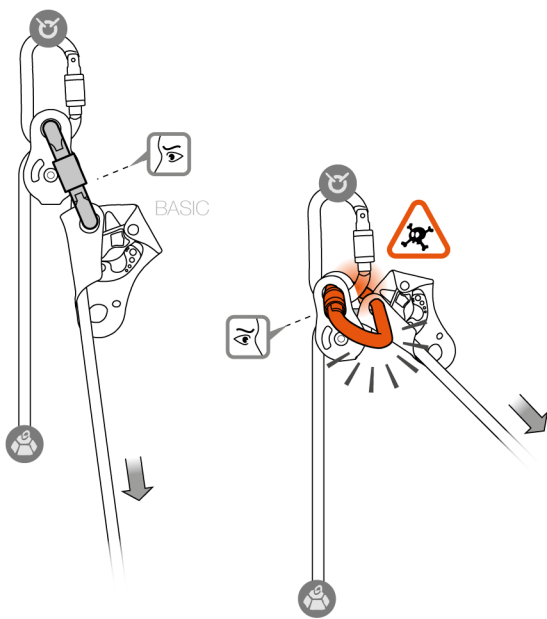

8. Positioning and redirection
Positionnement et renvoi

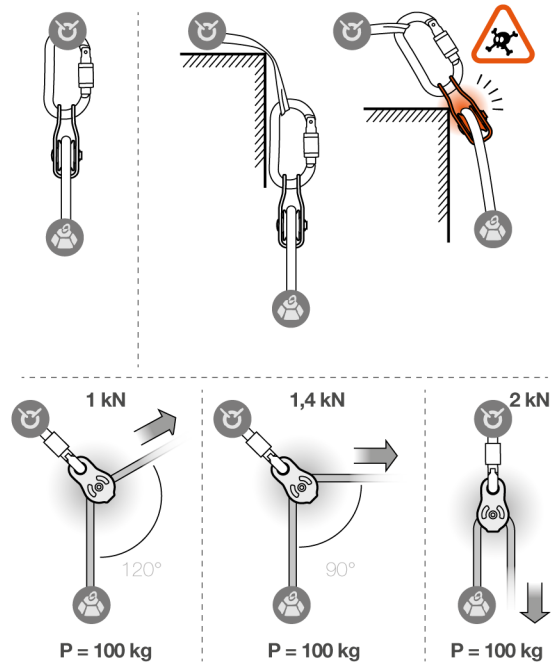

UKCA
0120

This product is compliant with the Regulation 2016/425 on Personal Protective Equipment as brought into UK law and amended.
Ce produit est conforme au règlement 2016/425 sur les équipements de protection individuelle tel que transposé en droit britannique et modifié.

Approved Body performing the UKCA type examination:
Organisme approuvé intervenant pour l'examen UKCA de type :

SATRA Technology Centre Limited
Wyndham Way, Telford Way,
Kettering, Northamptonshire,
NN16 8SD, United Kingdom.
N° 0321

Approved body responsible for the production control of this PPE:
Organisme approuvé responsable du contrôle de production de cet EPI :

SGS United Kingdom Ltd
Inward Way
Rossmore Business Park
Ellesmere Port, Cheshire, CH65 3EN
United Kingdom
N° 0120

Authorized Representative in UK : PETZL UK Agency, Unit 3-7, Tebay Business Park, Old Tebay, Penrith, CA10 3SS, United Kingdom